

Breezens®

Accurate, Fast and Reliable

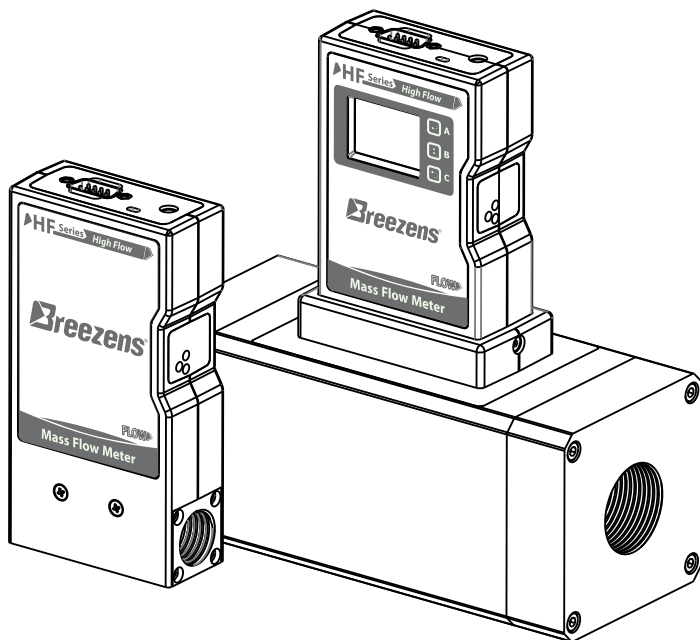

HF Series Mass Flow Meter

Visual Instruction & User Guide



March 2023









In The Name of
The Most Merciful

Index

- 1 Dimensions I
- 2 Dimensions II
- 3 Dimensions III
- 4 ATEX Requierments
- 5 Part Number Guide
- 6 Introduction I
- 7 Introduction II
- 8 Display Panel
- 9 Arrangement
- 10 Warm Up Process
- 10 Zero Check I
Via Display
- 10 Zero Check II
Via DB9 Port (Signal pin-5)
- 11 Zero Adjustment I
Via Display Panel (Auto)
- 12 Zero Adjustment II
Via Display Panel (Manual)
- 13 Zero Adjustment III
Via DB9 Port (Auto Zero Pin-7)
- 13 Zero Adjustment IV
Via Potentiometer
(Zero Adj. Potentiometer)
- 14 Signal
Db9 Port (Signal Pin-5)
Vs Display
- 15 Cutoff Adjustment
- 16 Flow Display Option
 - * Flow Percentage
 - * Standard Flow

- 17 Resolution Adjustment
- 18 Adjust
Operation(Current) Gas I
Via List
- 19 Adjust
Operation(Current) Gas II
Other Gas Adjustment
- 20 Error Status
- 20 Alarm Status
- 21 Error Reset I
Via Display Panel
- 21 Alarm Reset I
Via Display Panel
- 22 Error / Alarm Reset II
Via DB9 Port (Error Reset Pin-8)
- 22 LED Status
- 22 For Skilled Technical Expert
- 23 Factory Set

Symbols

- | | | | |
|---|-----------------|---|-----------------------------|
|  | Hold for 3 Sec. |  | Press n Times |
|  | Next Step |  | Few Steps Later |
|  | Internal Mode |  | External Mode |
|  | Attention |  | Skilled
Technical Expert |

Dimensions I

Up to 12 (m³/hr) with BSP

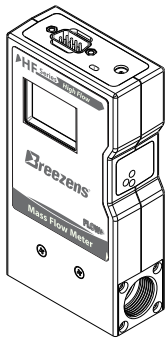
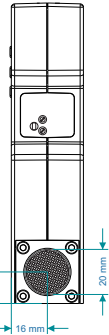
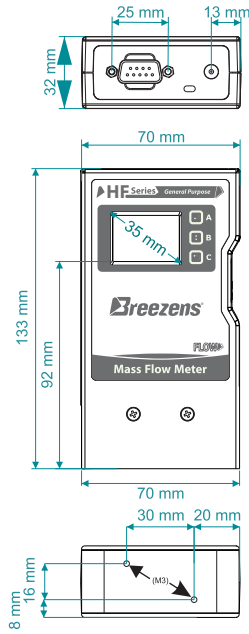
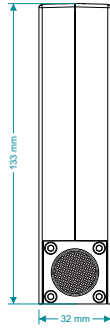
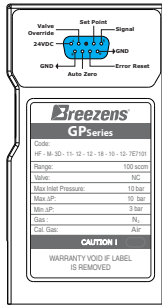

Up to 12 (m³/hr)
Steel 304
with BSP

KG ~ 500 gr
(w/o package)

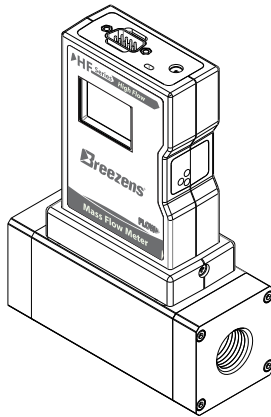

Up to 60 (m³/hr)
Aluminum
with BSP

KG ~ 600 gr
(w/o package)

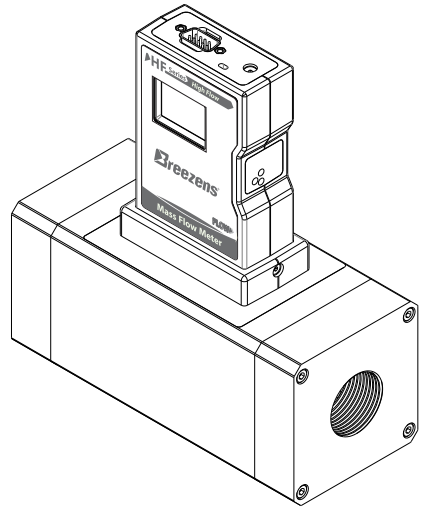

Above 60 (m³/hr)
Aluminum
with BSP

KG ~ 1900 gr
(w/o package)

Dimensions II

Up to 60 (m³/hr) with BSP

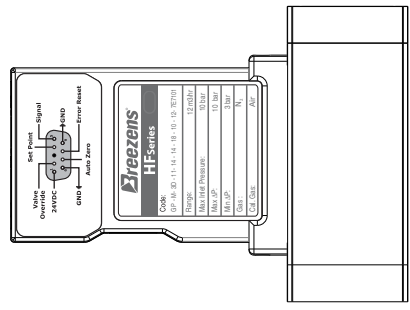
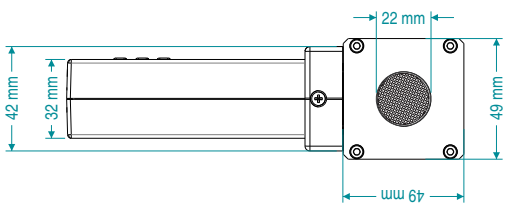
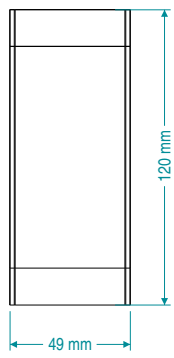
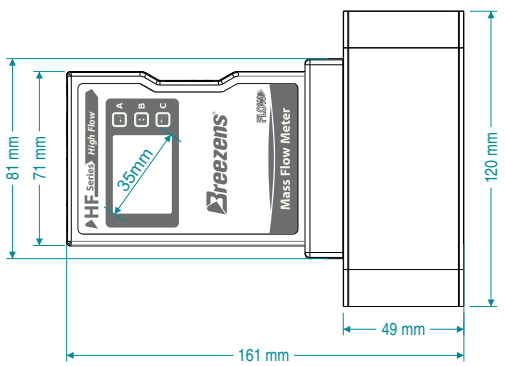
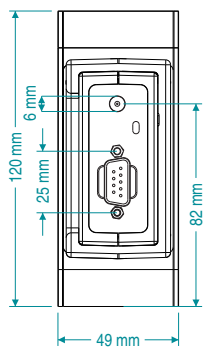

Dimensions III

Above 60 (m³/hr) with BSP

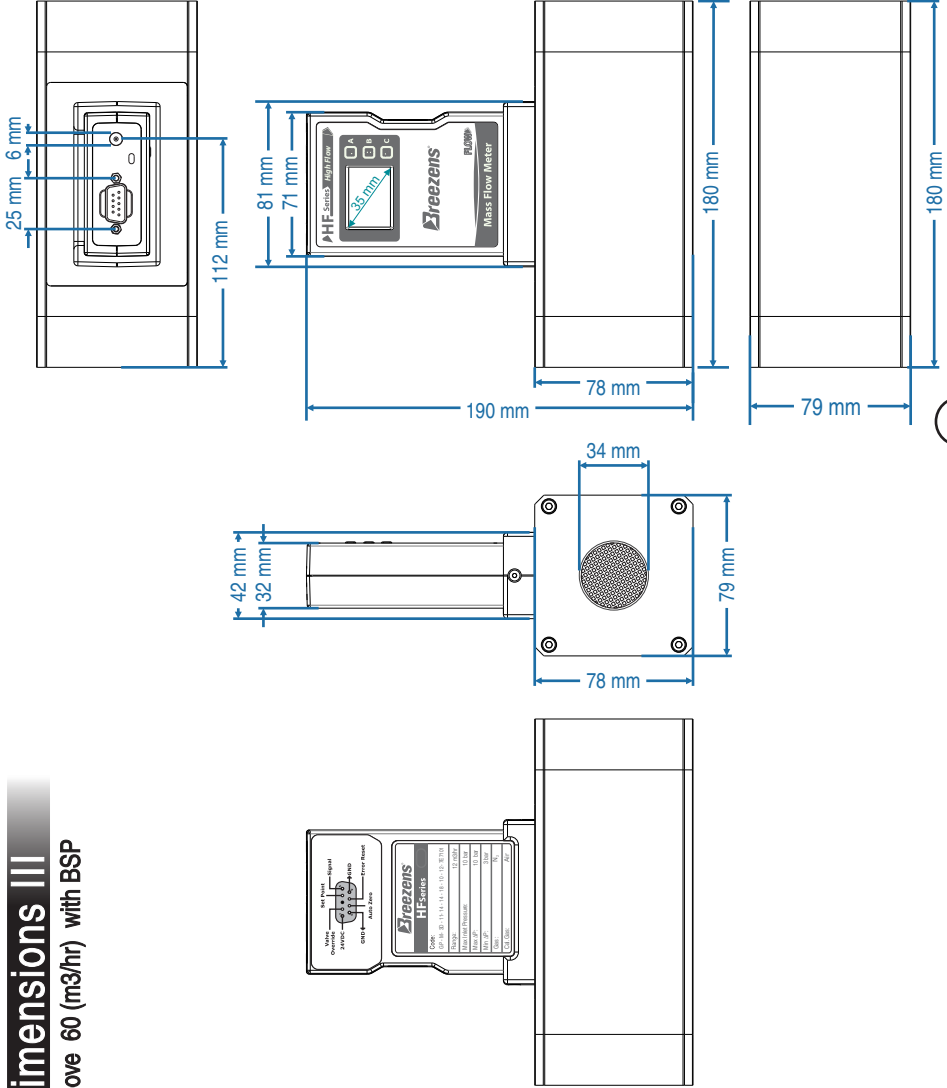



ATEX Requirements

* Standard
1 x 9 - pin
Female Sub-D
(DB9)

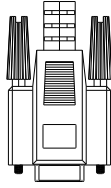

* Electrical Port
Shield

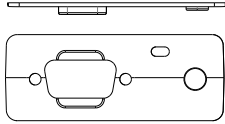

* Setting panel
Shield

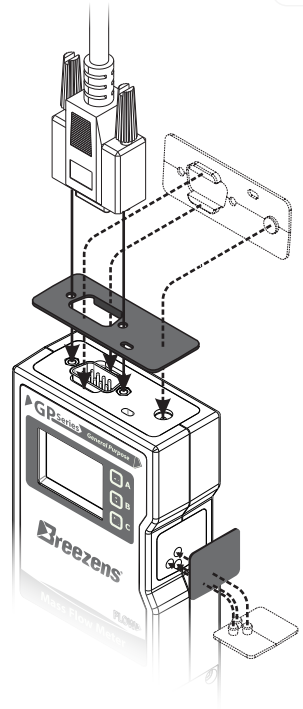
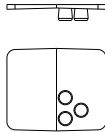

Part Number Guide

GP-X - XX - XX - XX - XX - XX - XX - XX - XXXXXX

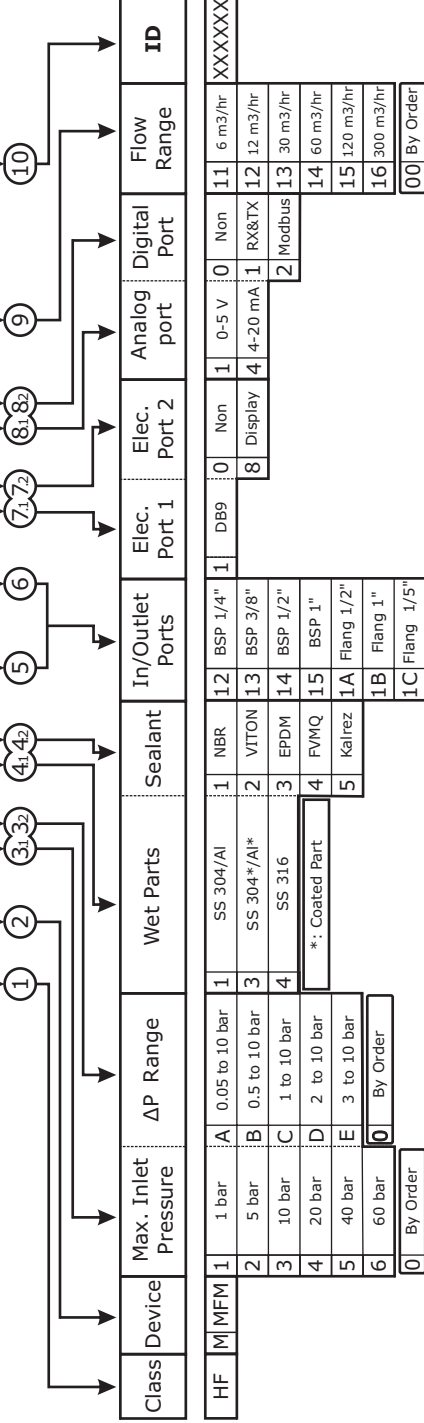

Class	Device	Max. Inlet Pressure	ΔP Range	Wet Parts	Sealant	In/Outlet Ports	Elec. Port 1	Elec. Port 2	Analog port	Digital Port	Flow Range	ID
HF	M	MFM	1	A	1	12	1	0	1	0	11	XXXXXX
		2	B	3	2	13	8	Display	4	1	12	12 m3/hr
		3	C	4	3	14				2	13	30 m3/hr
		4	D	4	4	15					14	60 m3/hr
		5	E	5	5	1A					15	120 m3/hr
		6	By Order	0	By Order	1B					16	300 m3/hr
		By Order				1C					By Order	
						1D						
						By Order						

Breezens
HF Series

Code: GP - M- 3D - 11- 14 - 18 - 10 - 12- 7E7101

Flange: 12 m3/hr

Max Inlet Pressure: 10 bar

Max ΔP: 10 bar

Min ΔP: 3 bar

Gas: N₂

Cal. Gas: Air

<p>① Class _____</p> <p>② Device _____</p> <p>③① Maximum Allowable Inlet Pressure _____</p> <p>③② Operating Pressure Difference Range _____</p> <p>④① Wet Part _____</p> <p>④② Sealant _____</p>	<p>⑤ Mechanical Gas Inlet Port _____</p> <p>⑥ Mechanical Gas Outlet Port _____</p> <p>⑦① Electronic Port 1 _____</p> <p>⑦② Electronic Port 2 _____</p> <p>⑧① Analog port _____</p> <p>⑧② Digital Port _____</p>
<p>⑨ Flow Range _____</p> <p>⑩ ID _____</p>	

Introduction I

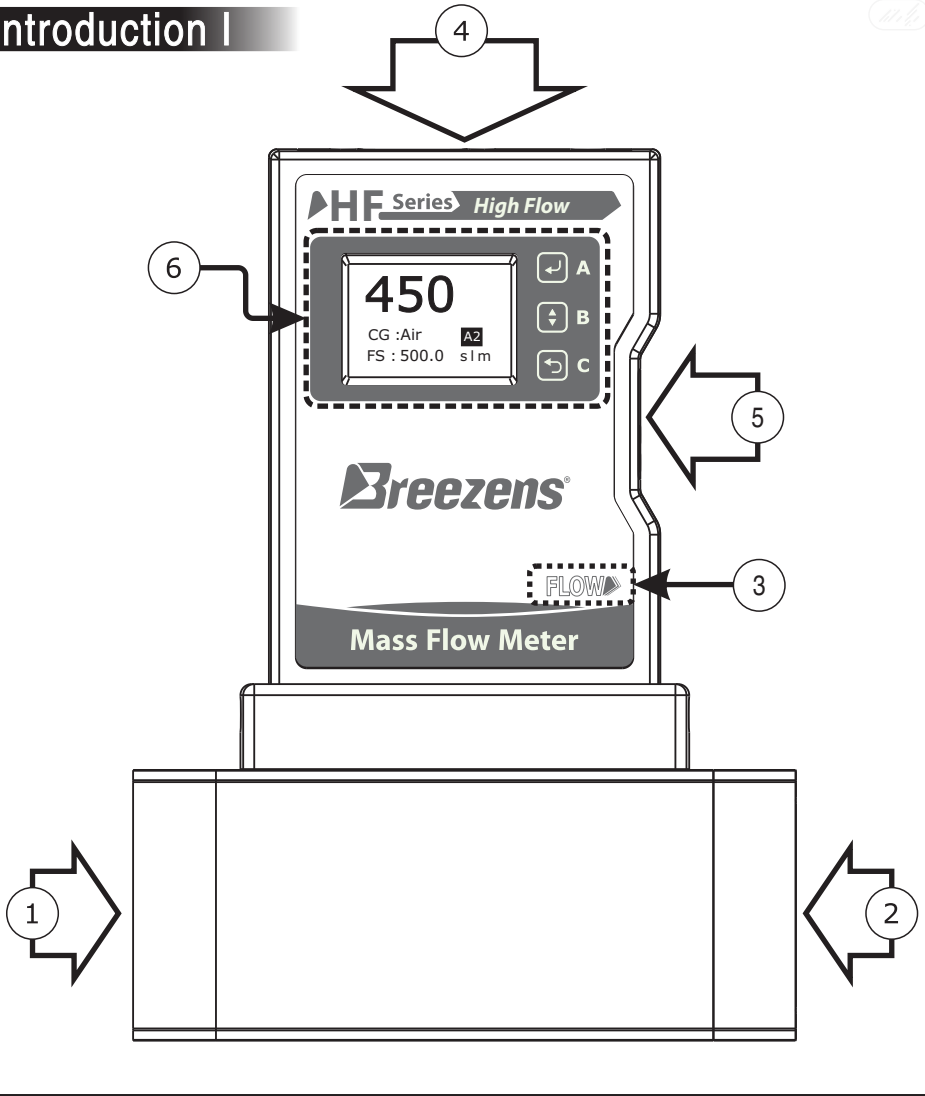

① Input Fitting
(BSP Female)

② Output Fitting
(BSP Female)

③ Attitude Indicator

④ Electrical Port

⑤ Setting panel

⑥ Display & Control panel

Introduction II

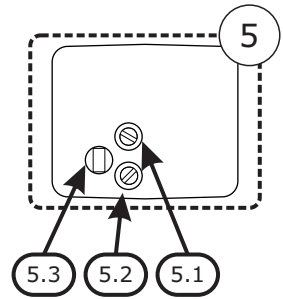
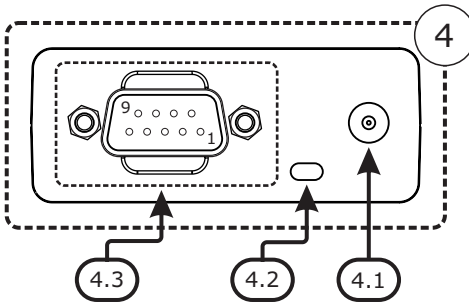
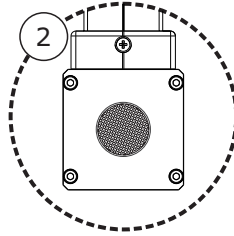
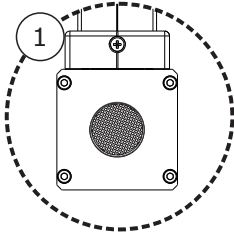

4

4.1 DC Power Jack (005)
(5.5x2.1mm)

4.2 3 Colors LED

4.3 1 x 9 - pin Male Sub-D (DB9)

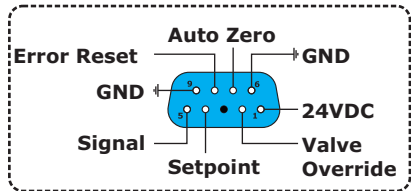

5

5.1 Zero Adjustment Potentiometer

5.2 Span Adjustment Potentiometer 

5.3 Auto Span Adjustment 

Display Panel

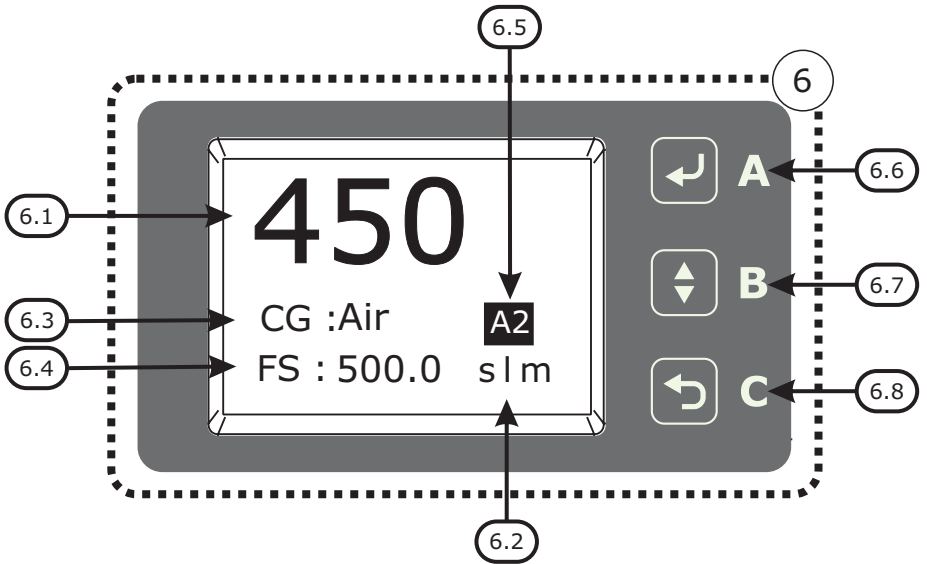

6

6.1 Flow Value

6.5 Error / Alarm

6.2 Flow Uni
slm:standard liter per minute

6.6 Key (A)
Select /Confirm

6.3 Current Gas

6.7 Key (B)
Scroll

6.4 Fullscale

6.8 Key (C)
Cancel

Arrangement

+24 V
20 ...25 VDC
< 7.2 Watt

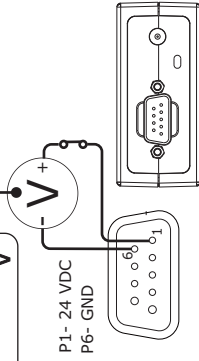

▶ 3 Way Hand Valve

▶ Pressure Regulator

▶ Filter

▶ Ball Valve

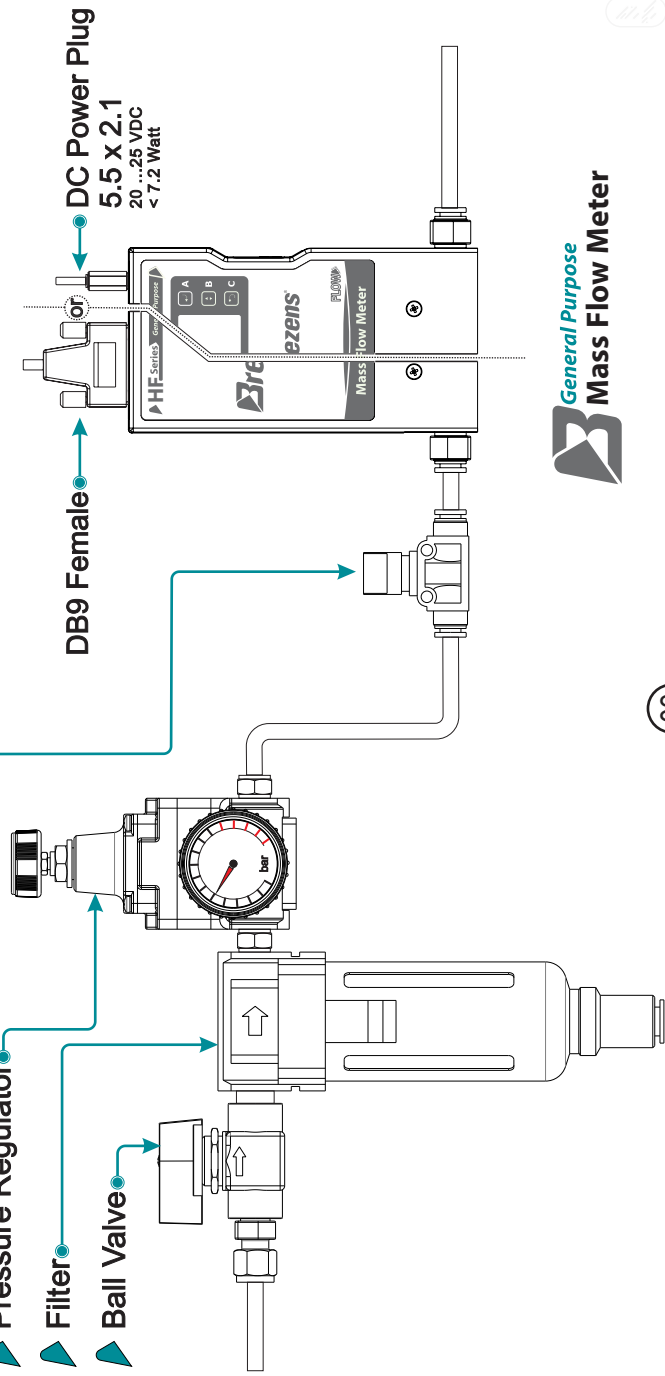

General Purpose
Mass Flow Meter

WarmUp Process

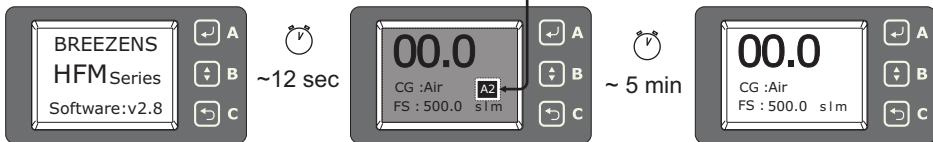

! 5 (min) for Acc ± 2.0 (FS)

! 45 (min) for Acc ± 1.5 (FS)

Zero Check I

Via Display

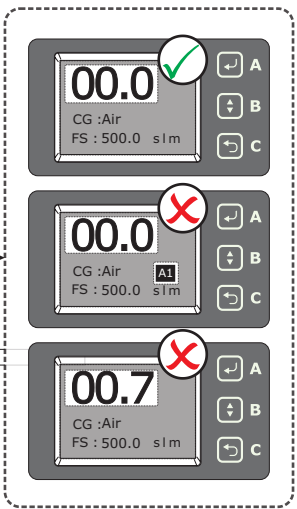
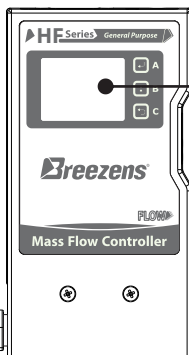
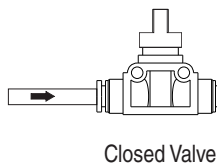

Zero Check II

Via DB9 Port (Signal Pin-5)

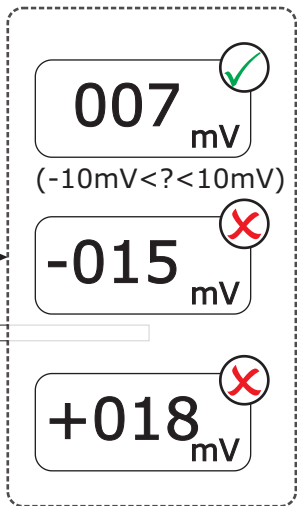
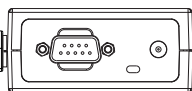
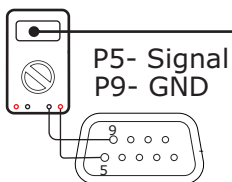
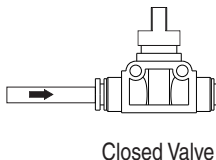

Zero Adjustment I

Via Display Panel (Auto)

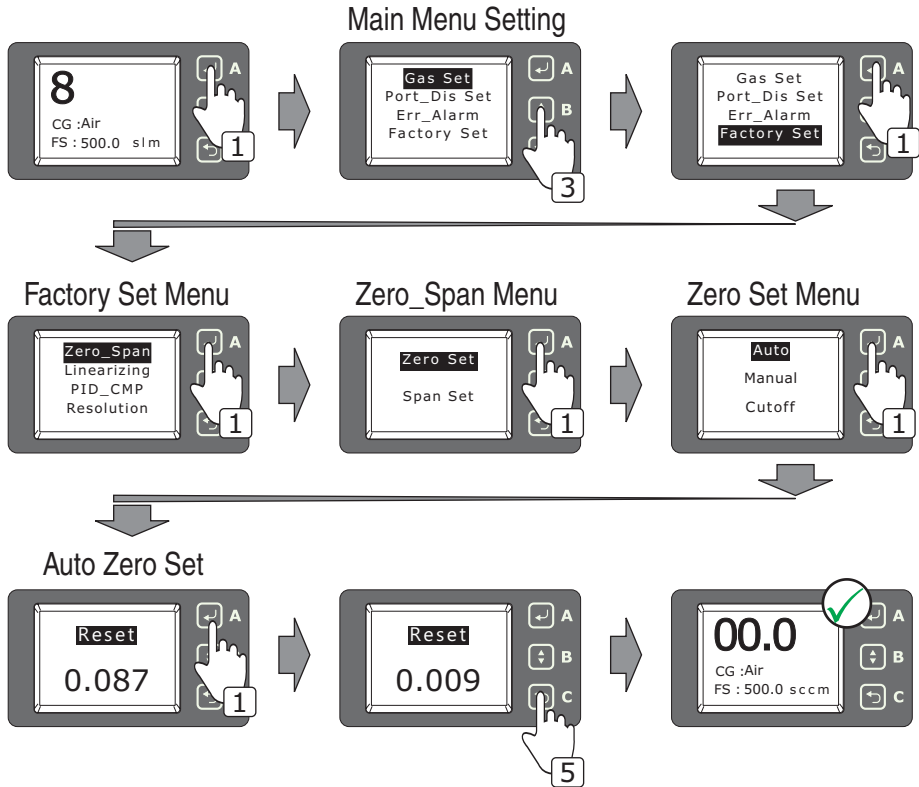

For Fine tune,

Temporarily reduce the Cutoff [P 11] value to 0.1% and after adjusting the Zero, return it to previous value



Note

Auto Zero Set is not very accurate, it is better to use the Manual Zero Set for more accurate adjustment



Zero Adjustment II

Via Display Panel (Manual)



P5- Signal
P9- GND

-87 mV

Example:
(-87 mV) Or (-0.087 V) Zero Offset

Zero Set Menu

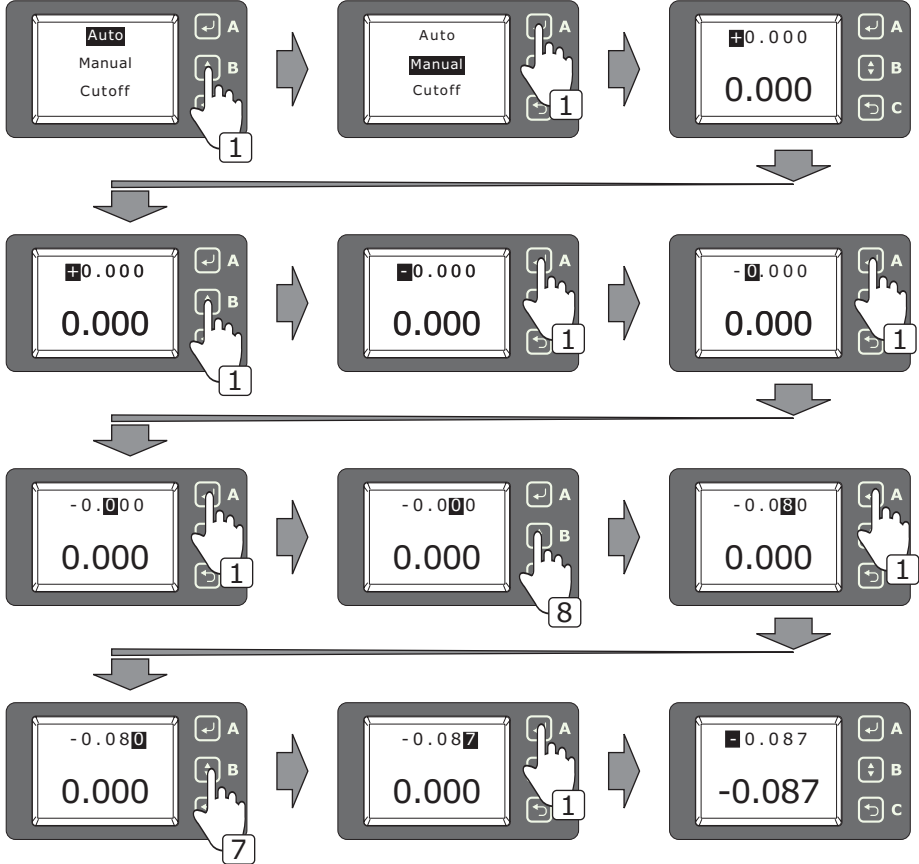

P5- Signal
P9- GND

007 mV

(-10mV < ? < 10mV)



Zero Adjustment III

Via DB9 Port (Auto Zero Pin-7)

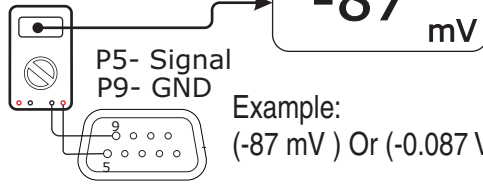

Example:
(-87 mV) Or (-0.087 V) Zero Offset

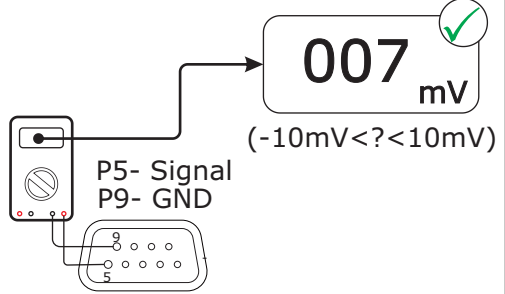
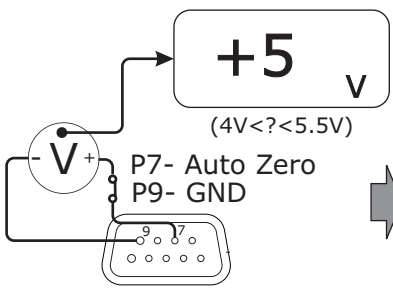

Zero Adjustment IV

Via Potentiometer (Zero Adj. Potentiometer)

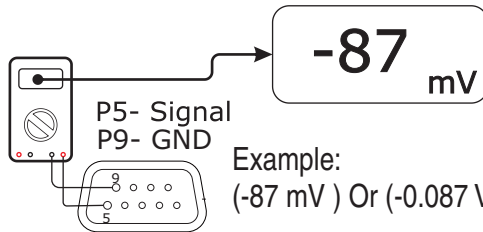

Example:
(-87 mV) Or (-0.087 V) Zero Offset

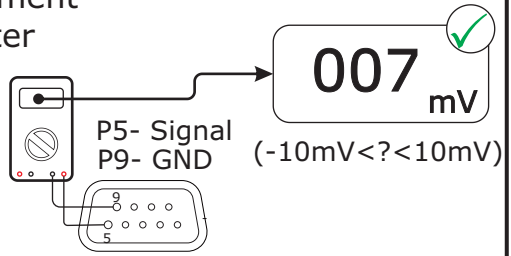
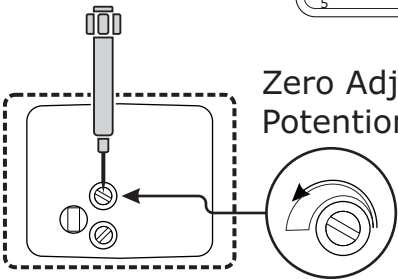



Signal

The DB9 Port (Signal Pin-5) VS Display

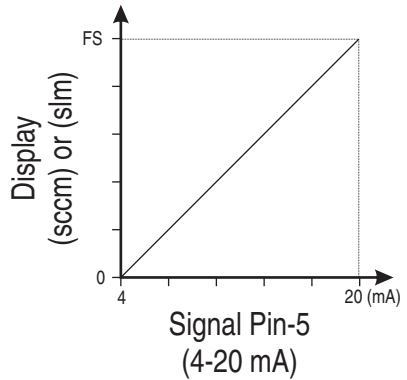
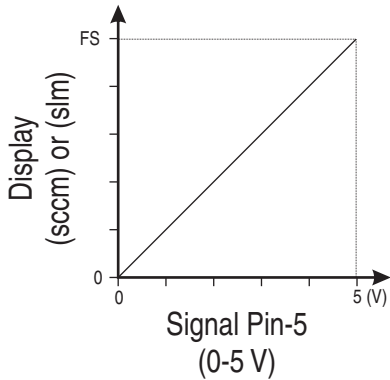

* Display [sccm]

Example:
Flow is 350 sccm
of 500 sccm FS



Minimum value in accordance with Turn Down Ratio
2% (FS)
1% (FS)(By Order)

* Voltage Signal
[0-5 V]

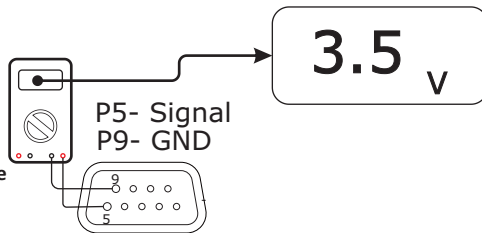

Minimum value in accordance with Turn Down Ratio
100 (mV)
50 (mV)(By Order)

* Current Signal
[4-20 mA]

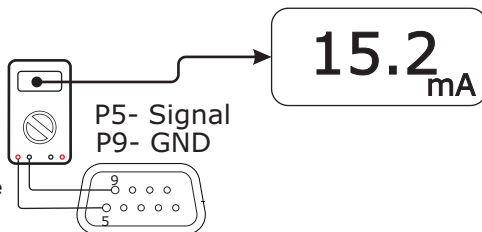

Minimum value in accordance with Turn Down Ratio
0.32(mA)
0.16 (mA)(By Order)

Cutoff Adjustment

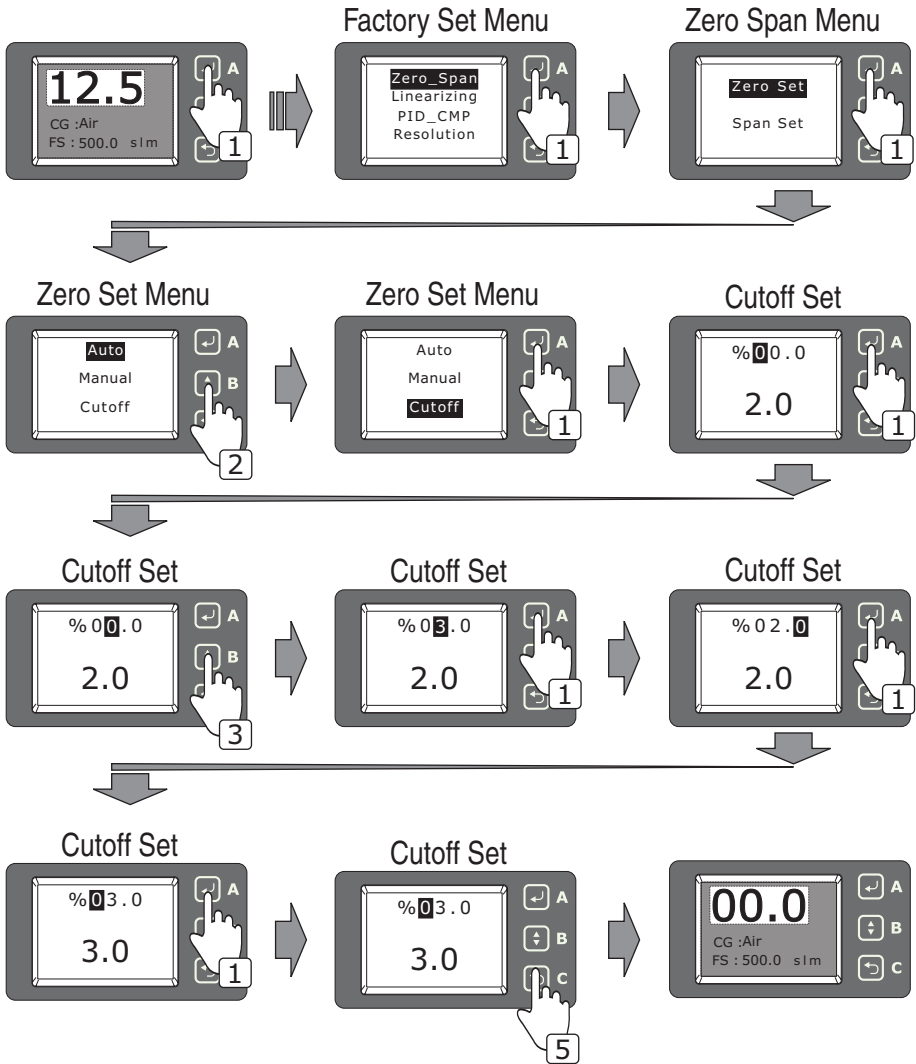

* For 500 sccm Fullscale
Change The Cutoff
from 2.0 to 3.0 % of FS



* For 500 sccm Fullscale
the minimum display Changes
from 10 sccm to 15 sccm



The Allowed Cut Off \geq 2% (FS)

Flow Display Option

Example:
Flow is 350 sccm
of 500 sccm FS

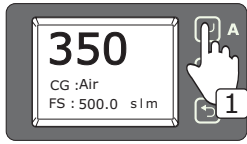

Main Menu Setting

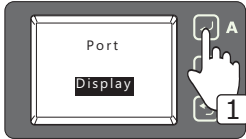
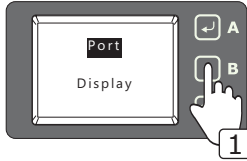
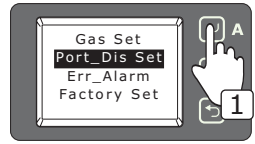
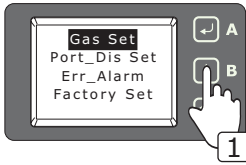

Display Show Set

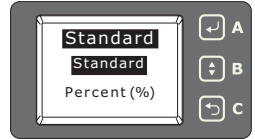

* Flow Percentage

Display Show Set

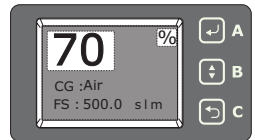
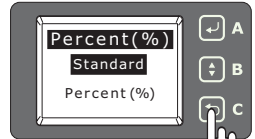
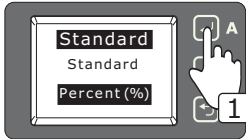
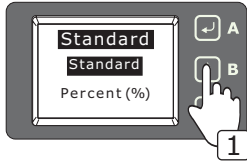

* Standard Flow

Display Show Set

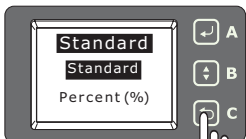
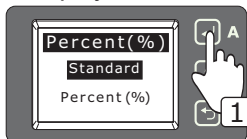

Resolution Adjustment

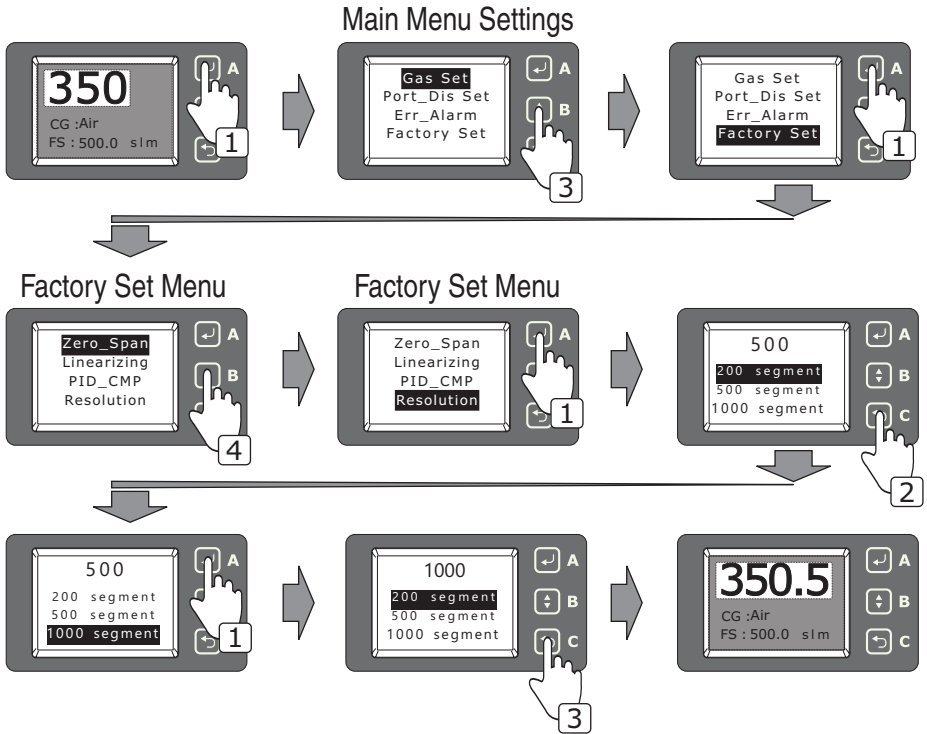

* For 500 sccm fullscale
change the resolution
from 500 to 1000



* For 500 sccm fullscale
the measurement resolution
changes from 1 sccm to 0.5 sccm



The Allowed Resolution ≤ 500
Resolution > 500 By Order

Adjust The Operation(Current) Gas I

Via The List

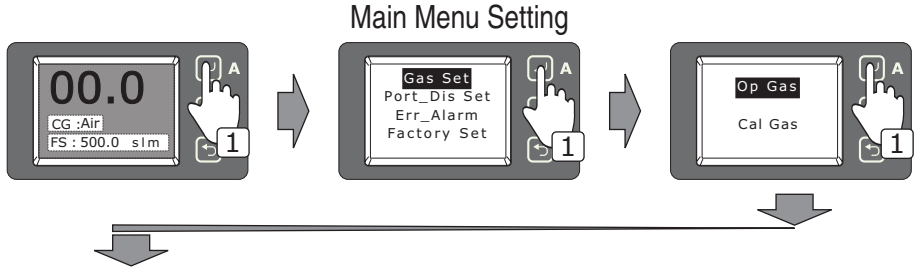

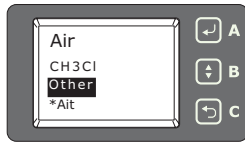

Gas Selection List

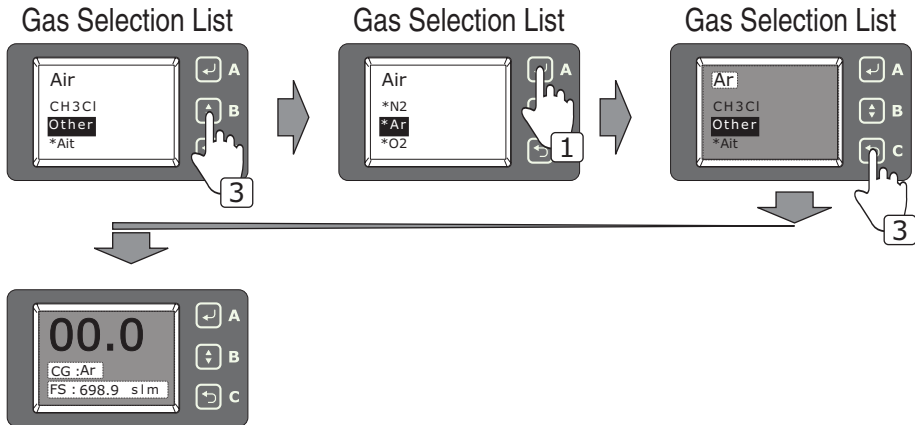

Example:

Operating (Current) Gas Changed to Argon (Ar)



 Allowed Operating Gases have an Asterisk (*)
Other Operating Gases By Order

Adjust The Operation (Current) Gas II

Other gases Adjustment

Main Menu Setting

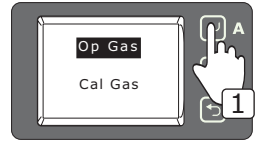
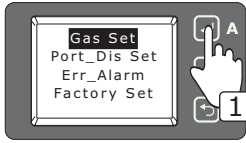
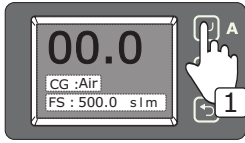

Gas Selection List



Example:

Operating (Current) Gas changed to an undefined Gas
Gas Correction Factor : 1.45

Gas Selection List

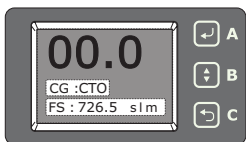
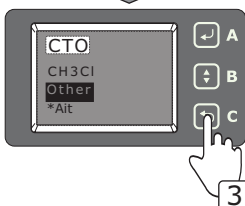
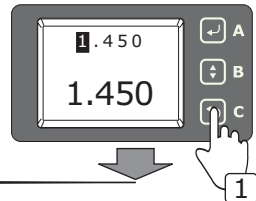
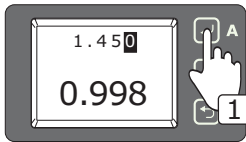
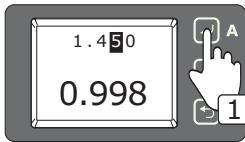
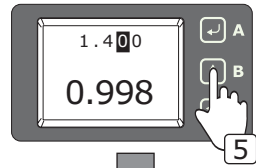
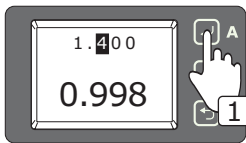
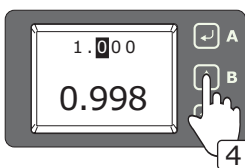
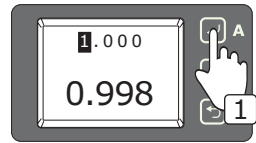
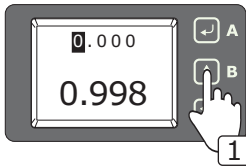
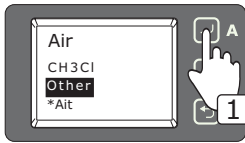

Error Status

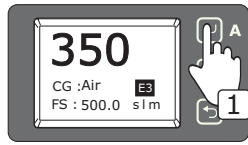

Main Menu Setting

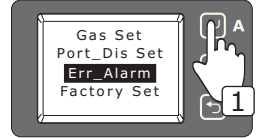
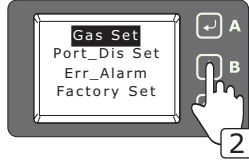

Error Alarm Menu

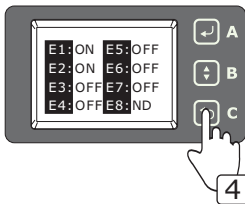
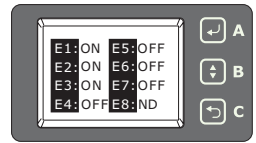
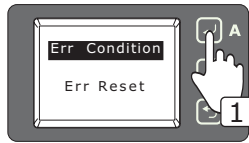
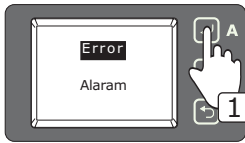

- * OFF: Ex Not Activated Error Code
- * ON: Ex Activated Error Code
- * ND: Ex Not Defined Error Code

Alarm Status

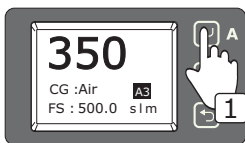

Error Alarm Menu

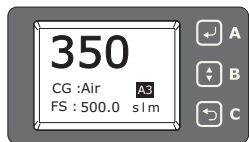
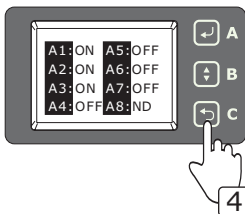
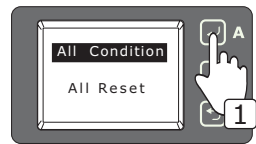
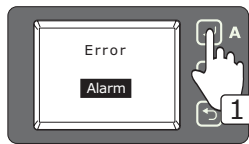

- * OFF: Ax Not Activated Alarm Code
- * ON: Ax Activated Alarm Code
- * ND: Ax Not Defined Alarm Code

Error Reset I

Via Display Panel

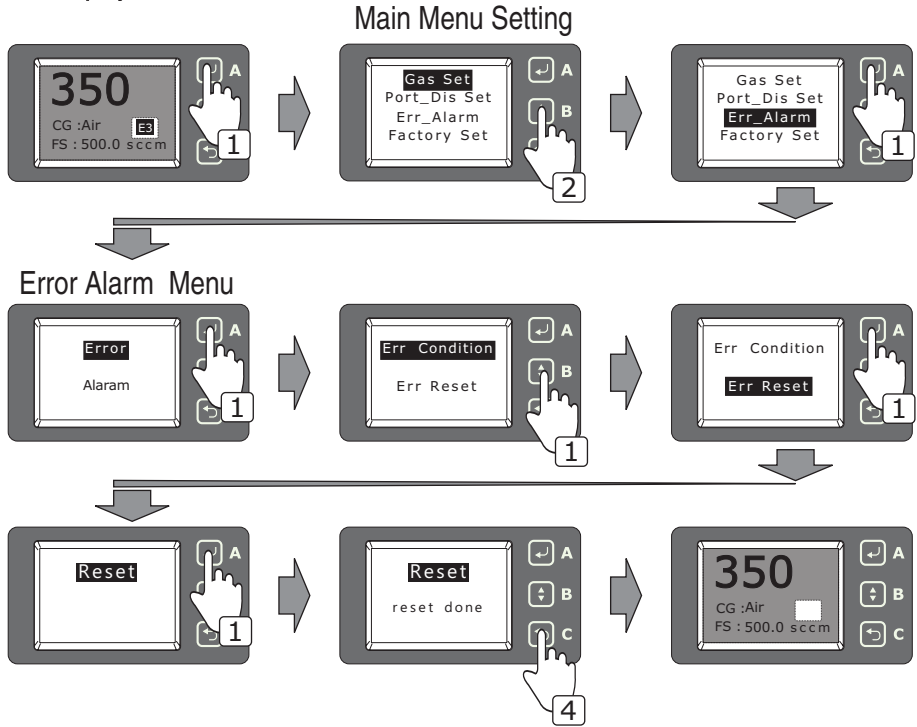

Alarm Reset I

Via Display Panel

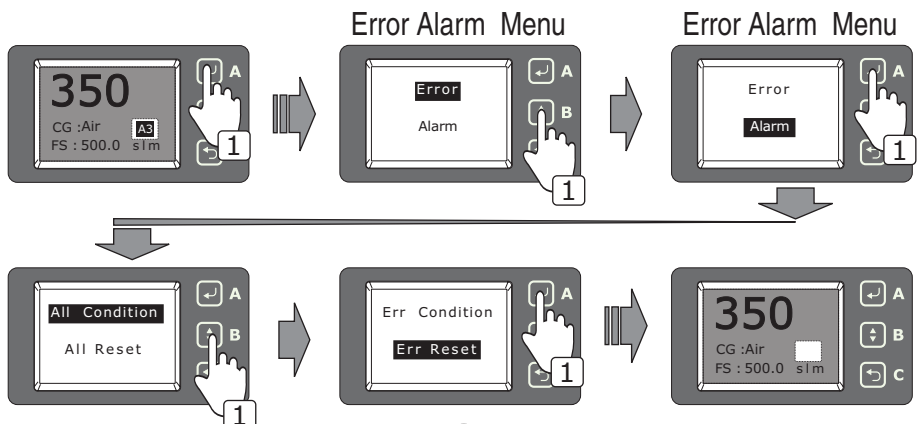



Error / Alarm Reset II

Via DB9 Port (Error Reset Pin-8)

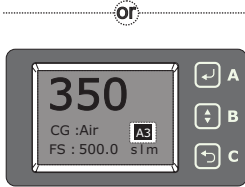
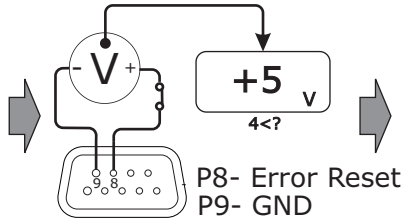

LED Status

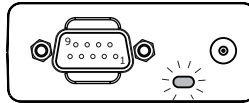

Green: ON/Normal

Yellow : Alarm

Red : Error



For Skilled Technical Expert



Only the authorized technical expert of the company is allowed to set SPAN

Factory Set Menu

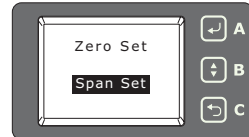
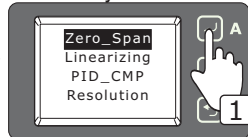

Only the authorized technical expert of the company is allowed to set LINEARIZING

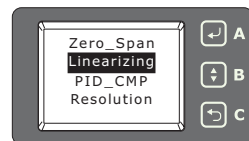
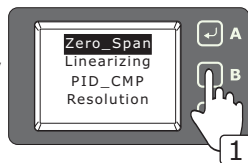

Factory Set



Main Menu Settings

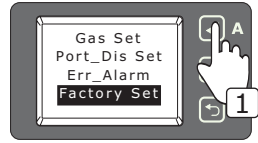
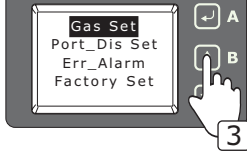
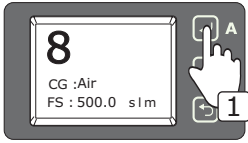

Password

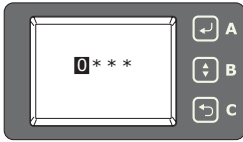

Password Example: 1400

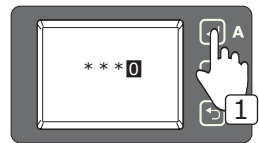
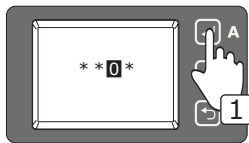
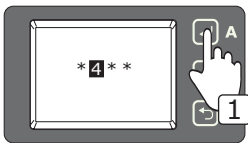
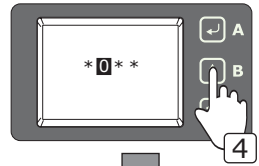
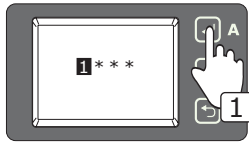
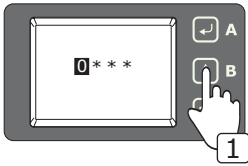

Factory Set Menu

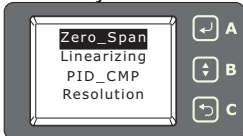

Note:

A series of 20 horizontal dotted lines for writing notes.

Note:

A series of horizontal dashed lines for writing.

Note:

